

PVC FLOAT VALVES, BALLS, AND RODS

Corrosion Resistant



PVC



MerickValve INCORPORATED

MANUFACTURER OF FLOAT VALVES AND ACCESSORIES

Phone: 904-732-2258

Website: www.floatvalve.com

Kerick Valve

"M" Series Float Valves

Kerick's "M" series float valves are available in two different styles. The adjustable arm style "MA" and the fixed arm style "M". Both are tank (bulkhead) mountable.



M252 - 1/4" tubing inlet, fixed arm*



MA252 - 1/4" tubing inlet, adjustable arm*



M382 - 3/8" tubing inlet, fixed arm*



MA382 - 3/8" tubing inlet, adjustable arm*



M052 - 1/2" pipe thread inlet, fixed arm**



MA052 - 1/2" pipe thread inlet, adjustable arm **



MB22 - 1/4" barb inlet, fixed arm



MAB22 - 1/4" barb inlet, adjustable arm



M2S2 - 1/4" pipe thread inlet, fixed arm



MA2S2 - 1/4" pipe thread inlet, adjustable arm



M2P2 - 1/4" extended pipe thread inlet, fixed arm***



MA2P2 - 1/4" extended pipe thread inlet, adjustable arm ***



M3P2 - 3/8" pipe thread inlet, fixed arm



MA3P2 - 3/8" pipe thread inlet, adjustable arm

*Tubing inlet models utilize JACO compression nuts for plastic tubing

**1/2" valves can be tapped with 1/4" female pipe thread

***Optional bulkhead nut

Kerick Valve offers a non-corrosive, heavy duty, high-quality PVC alternative for fluid level control. Kerick's patented design utilizes the latest materials for increased performance, reliability, and economy. Our PVC float valves are the cost-effective alternative to stainless steel and the non-corrosive alternative to brass float valves.

Kerick Valve

"M" Series Float Valves

- All "M" series valves have a .093 orifice with a free flow outlet. Estimated flow rate is 1.3 GPM @ 40 PSI and 1.5 GPM @ 60 PSI and all have been tested to 100 PSI
- Standard valves are made with NSF approved PVC
- Seals are made of long-wearing and chemical resistant Satnprene® rubber
- Standard hardware is made of 18-8 stainless steel
- Valves come complete with jam nut, sealing washer, and polyethylene float attached
- "MA" models can be mounted vertically

APPROXIMATE DIMENSIONS IN INCHES				
MODEL	A	B	C	D
M052	6.7	1	N/A	N/A
M252	6.7	1	N/A	N/A
M382	6.7	1	N/A	N/A
MA052	7.5	1	N/A	N/A
MA252	7.5	1	N/A </td <td>N/A</td>	N/A
MA382	7.5	1	N/A	N/A
PS75SS	4.8	N/A	1.5	1.5
PT75SS	5.25	1.15	1.5	2
PS75LS	4.8	N/A	1.5	1.5
PT75LS	5.25	1.15	1.5	2
PX75SS	5.25	N/A	1.5	2
PS100SS	6	N/A	1.8	1.8
PT100SS	7	1.3	1.8	2.7
PS125SS	9	N/A	2.7	2.7
PS150SS	9	N/A	2.7	2.7

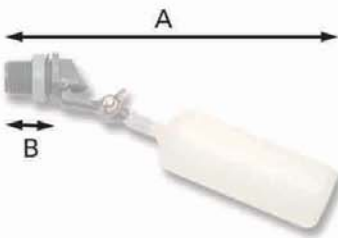
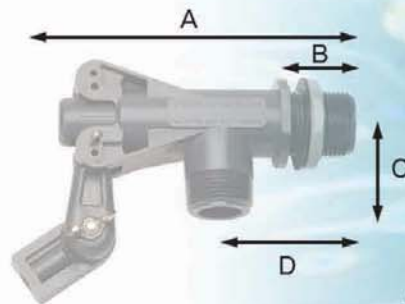

"M" SERIES VALVES CAN BE CUSTOMIZED TO MEET OEM REQUIREMENTS SEE PAGE 7 FOR FLOAT OPTIONS

Installation Diagram

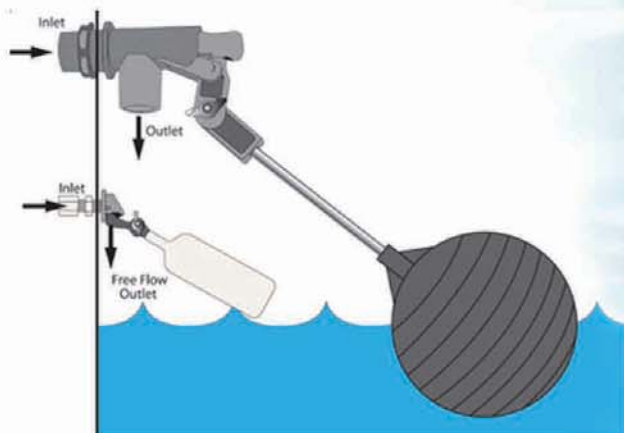

Kerick Valve

3/8" & 1/2" HEAVY DUTY NON CORROSIVE PVC FLOAT VALVES

Kerick's 3/8" and 1/2" valves are available with three different orifice sizes: .187", .25", and .312" in order to match required flow range.

- Standard valves are made with NSF approved PVC
- Hardware made with 18-8 stainless steel
- Replaceable seals are made of long-wearing and chemical resistant Santoprene® rubber
- Use with 3" or 6" rod and 4x5" or 2x2x4" float
 - *see page 7 for float options
- .187" orifice has an estimated flow rate of 4.4 GPM @ 20 PSI and 7.2 GPM @ 60 PSI
- .25" orifice has an estimated flow rate of 7.7 GPM @ 20 PSI and 12.5 GPM @ 60 PSI
- .312" orifice has an estimated flow rate of 8 GPM @ 20 PSI and 15 GPM @ 60 PSI

Installation Diagram

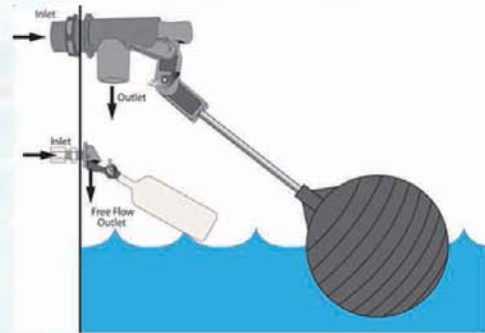

PS3838xxx* - Standard mount

- 3/8" pipe thread inlet and outlet



PT3838xxx* - Tank (bulkhead) mount

- 3/8" pipe thread inlet and outlet
- Extended threads on the inlet side of the valve for mounting through a tank wall
- Comes complete with sealing washer and jam nut



PS0505xxx* - Standard mount

- 1/2" pipe thread inlet and outlet



PT0505xxx* - Tank (bulkhead) mount

- 1/2" pipe thread inlet and outlet
- Extended threads on the inlet side of the valve for mounting through a tank wall
- Comes complete with sealing washer and jam nut

Kerick Valve

3/4" HEAVY DUTY NON-CORROSIVE
PVC FLOAT VALVES

- Standard valves are made with NSF approved PVC
- Hardware made with 18-8 stainless steel
- Replaceable seals are made of long-wearing and chemical resistant Santoprene® rubber

PS75SS - Standard mount

- .48" orifice
- 3/4" inlet and outlet
- Estimated flow rates of 27.5 GPM @ 30 PSI and 37 GPM @ 60 PSI
- Use with 12"x1/4" stainless steel rod and 6" float



PT75SS - Tank (bulkhead) mount

- .48" orifice
- 3/4" inlet and outlet
- Estimated flow rates of 27.5 GPM @ 30 PSI and 37 GPM @ 60 PSI
- Use with 12"x1/4" stainless steel rod and 6" float
- Extended threads on the inlet side of the valve for mounting through a tank wall
- Comes complete with sealing washer and jam nut



PS75LS - Standard mount

- .30" orifice
- 3/4" inlet and outlet
- Estimated flow rates of 13 GPM @ 30 PSI and 16.5 GPM @ 60 PSI
- Use with 12"x1/4" stainless steel rod and 4x5" float
- Size of rod may be reduced when using less than maximum pressure



PT75LS - Tank (bulkhead) mount

- .30" orifice
- 3/4" inlet and outlet
- Estimated flow rates of 13 GPM @ 30 PSI and 16.5 GPM @ 60 PSI
- Use with 12"x1/4" stainless steel rod and 4x5" float
- Size of rod may be reduced when using less than maximum pressure
- Extended threads on the inlet side of the valve for mounting through a tank wall
- Comes complete with sealing washer and jam nut



PX75SS - Standard mount extended inlet

- .48" orifice
- 3/4" inlet and outlet
- Estimated flow rates of 27.5 GPM @ 30 PSI and 37 GPM @ 60 PSI
- Use with 12"x1/4" stainless steel rod and 6" float



Kerick Valve

1" TO 1.5" HEAVY DUTY
NON CORROSIVE
PVC FLOAT VALVES

Kerick's 1" through 1.5" float valves have lever brackets on both sides so they can be used upside-down. Two fulcrum positions on the lever add further flexibility to accommodate different pressures and flow rates.

- Standard valves are made of NSF approved PVC
- Hardware made with 18-8 stainless steel
- Replaceable seals are made of long-wearing and chemical resistant Santoprene® rubber



PS100SS - Standard Mount

- 1" inlet and outlet
- .69" orifice
- Estimated flow rates of 42 GPM @ 30 PSI and 56 GPM @ 60 PSI*
- Estimated flow rates of 51 GPM @ 30 PSI and 69 GPM @ 60 PSI**
- Use with 12"x1/4" stainless steel rod and 6" or 8" float ball



PT100SS - Tank (bulkhead) mount

- 1" inlet and outlet
- .69" orifice
- Estimated flow rates of 42 GPM @ 30 PSI and 56 GPM @ 60 PSI*
- Estimated flow rates of 51 GPM @ 30 PSI and 69 GPM @ 60 PSI**
- Use with 12"x1/4" stainless steel rod and 6" or 8" float ball
- Extended threads on the inlet side of the valve for mounting through a tank wall
- Comes complete with sealing washer and jam nut



PT100LS - Tank (bulkhead) mount

- 1" inlet and outlet
- .38" orifice
- Estimated flow rates of 12 GPM @ 30 PSI and 16 GPM @ 60 PSI*
- Estimated flow rates of 19 GPM @ 30 PSI and 26 GPM @ 60 PSI**
- Use with 12"x1/4" stainless steel rod and 6" or 8" float ball
- Extended threads on the inlet side of the valve for mounting through a tank wall
- Comes complete with sealing washer and jam nut



PS125SS - Standard mount

- 1.25" inlet and outlet
- 1.0" orifice
- Estimated flow rates of 85 GPM @ 20 PSI and 124 GPM @ 50 PSI*
- Estimated flow rates of 90 GPM @ 20 PSI and 145 GPM @ 50 PSI**
- Use with 5/16" threaded stainless steel rod in 14", 16", or 18" length and an 8" float ball



PS150SS - Standard mount

- 1.25" inlet and outlet
- 1.0" orifice
- Estimated flow rates of 85 GPM @ 20 PSI and 124 GPM @ 50 PSI*
- Estimated flow rates of 90 GPM @ 20 PSI and 145 GPM @ 50 PSI**
- Use with 5/16" threaded stainless steel rod in 14", 16", or 18" length and an 8" float ball

*Position # 1 (Low Flow)

**Position # 2 (High Flow)

Kerick Valve

FLOAT BALLS AND RODS



PF45 - This 4x5" float ball works well with the low flow valves that have a .30" orifice such as the PS75LS and PT75LS. This float also works well with the PS3838xxx, PT3838xxx, PS0505xxx, and PT0505xxx float valves.



PF06 - This 6" polyethylene float ball resists corrosion, has no seams to leak, and is resistant to sunlight deterioration. It has a 1/4" self-tapping connection for use with all of the 3/4" and 1" valves. Connection can be enlarged for 5/16" rods.



PF08 - This 8" polyethylene float ball resists corrosion, has no seams to leak, and is resistant to sunlight deterioration. It has a 5/16" self-tapping connection for use with the PS125SS and PS150SS valves. A 1/4" connection is also available for use with the PS100SS and PT100SS float valves.

PF224 - This 2x2x4" rectangle float works well with the PS3838xxx, PT3838xxx, PS0505xxx, and PT0505xxx float valves.



PF444 - This 4x4x4" square float works well with the low flow valves that have a .30" orifice such as the PS75LS and the PT75LS. This float also works well with the PS3838xxx, PT3838xxx, PS0505xxx, and PT0505xxx float valves.



'M' SERIES POLYETHYLENE FLOAT OPTIONS

PF152 - 1.5x2" cylinder



PF153 - 1.5x3" cylinder



PF154 - 1.5x4" cylinder

*comes standard



PF1753 - 1.75x3" cylinder



PF224 - 2x2x4" rectangle



PF222 - 2x2x2" square



RODS

SR03 3" x 1/4"

SR06 6" x 1/4"

SR08 8" x 1/4"

SR10 10" x 1/4"









SR12 12" x 1/4"

SR14 14" x 5/16"

SR16 16" x 5/16"

SR18 18" x 5/16"

PARTS LIST

									
	Lever	Arm	Cotter Pin	Carriage Bolt	Wing Nut	Bulkhead Gasket	Bulkhead Nut	Disk Seal	Compression Nut
Model #	Part #	Part #	Part #	Part #	Part #	Part #	Part #	Part #	Part #
M252	LVM2	None	CPM	None	None	BGM25	BNM25	DSM	CNM25
MA252	LVMA2	AMMA2	CPM	CBMA	WNMA	BGM25	BNM25	DSM	CNM25
M052	LVM2	None	CPM	None	None	BGM05	BNM05	DSM	None
MA052	LVMA2	AMMA2	CPM	CBMA	WNMA	BGM05	BNM05	DSM	None
M382	LVM2	None	CPM	None	None	BGM38	BNM38	DSM	CNM38
MA382	LVMA2	AMMA2	CPM	CBMA	WNMA	BGM38	BNM38	DSM	CNM38
MB22	LVM2	None	CPM	None	None	BGM25	BNM25	DSM	None
MAB22	LVMA2	AMMA2	CPM	CBMA	WNMA	BGM25	BNM25	DSM	None
M2S2	LVM2	None	CPM	None	None	None	None	DSM	None
MA2S2	LVMA2	AMMA2	CPM	CBMA	WNMA	None	None	DSM	None
M2P2	LVM2	None	CPM	None	None	None	BN25*	DSM	None
MA2P2	LVMA2	AMMA2	CPM	CBMA	WNMA	None	BN25*	DSM	None
M3P2	LVM2	None	CPM	None	None	None	None	DSM	None
MA3P2	LVMA2	AMMA2	CPM	CBMA	WNMA	None	None	DSM	None

*Optional parts

										
	Lever	Arm	Cotter Pin	Carriage Bolt	Wing Nut	Bulkhead Gasket	Bulkhead Nut	Disk Seal	Cup Seal	Piston
Model #	Part #	Part #	Part #	Part #	Part #	Part #	Part #	Part #	Part #	Part #
PS3838xxx	LV05	AM05	CP05	CBMA	WNMA	None	None	DS05	CS05	PT05
PT3838xxx	LV05	AM05	CP05	CBMA	WNMA	BGM38	BN38	DS05	CS05	PT05
PS0505xxx	LV05	AM05	CP05	CBMA	WNMA	None	None	DS05	CS05	PT05
PT0505xxx	LV05	AM05	CP05	CBMA	WNMA	BGM05	BNM05	DS05	CS05	PT05
PS75SS	LV75	AM75	CP75	CB75	WN75	None	None	DS75	CS75	PT75
PT75SS	LV75	AM75	CP75	CB75	WN75	BG75	BN75	DS75	CS75	PT75
PS75LS	LV75	AM75	CP75	CB75	WN75	None	None	DS75	CS75	PT75
PT75LS	LV75	AM75	CP75	CB75	WN75	BG75	BN75	DS75	CS75	PT75
PX75SS	LV75	AM75	CP75	CB75	WN75	None	None	DS75	CS75	PT75
PS100SS	LV100	AM100	CP100	CB75	WN75	None	None	DS100	CS100	PT100
PT100SS	LV100	AM100	CP100	CB75	WN75	BG100	BN100	DS100	CS100	PT100
PT100LS	LV100	AM100	CP100	CB75	WN75	BG100	BN100	DS100	CS100	PT100
PS125SS	LV150	AM150	CP150	CB150	WN150	None	None	DS150	CS150	PT150
PS150SS	LV150	AM150	CP150	CB150	WN150	None	None	DS150	CS150	PT150